

رابعاً المستويات المتعامدة  
تمارين

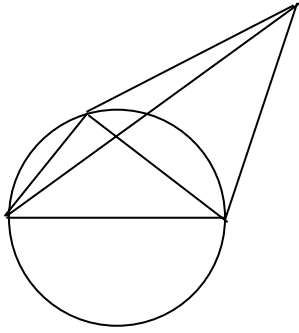

$\perp$  —

:( ) —

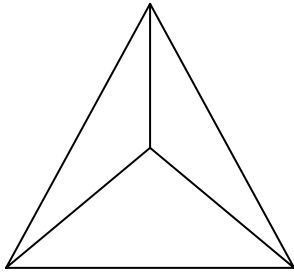
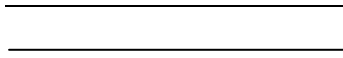

:( ) —

$\perp$

:

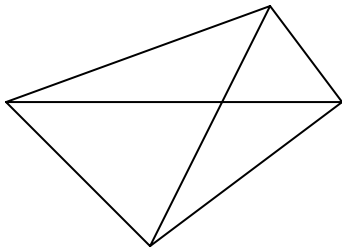

$\perp$  —

:( ) —

:

= ( ^ )

$\perp$  — -

$\perp$

-

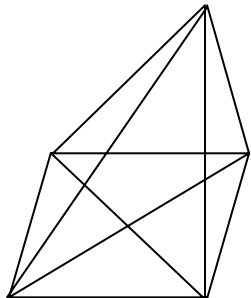

$\perp$  —

:( ) —

( )

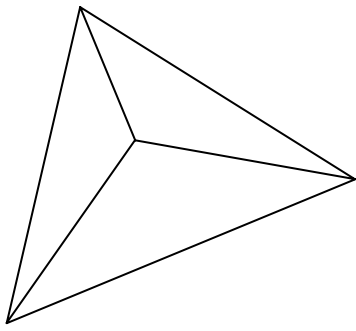

$\triangle$   $\perp$   $\triangle$   
 $\perp$   
 $\triangle$

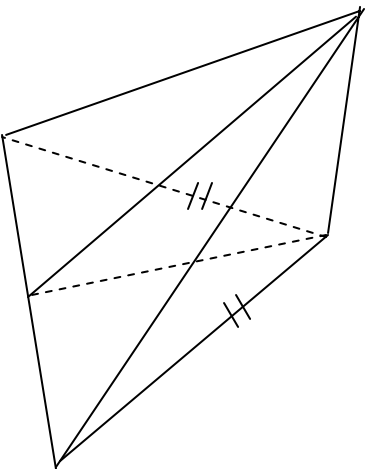

$\triangle$   $\perp$   $\triangle$   
 $\perp$   
 $\triangle$

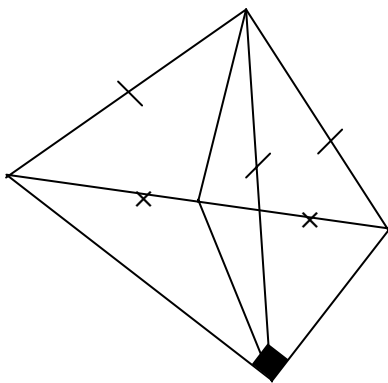

$\triangle$   $\perp$   $\triangle$   
 $\perp$   
 $\triangle$

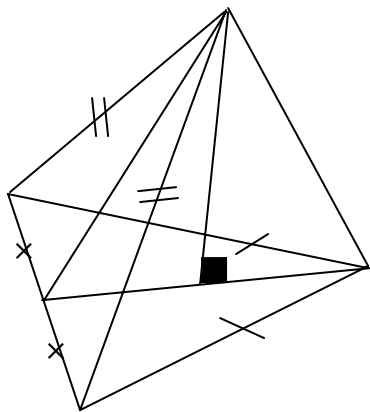

:( )

=  
:  
⊥

:( )

=  
° = ( ^ )  
:  
⊥

:( )

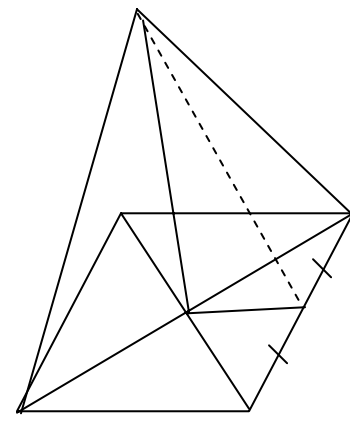

=  
:  
⊥

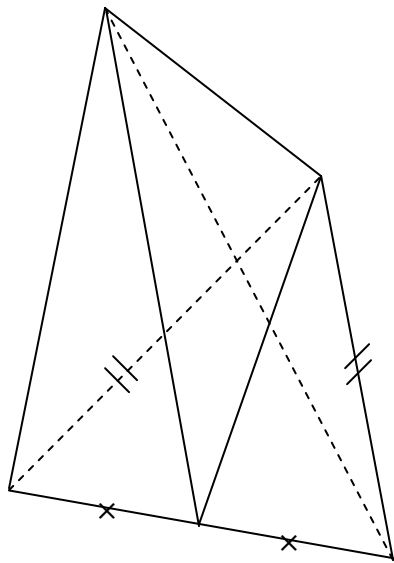

:( ) \_\_\_\_\_

:

= =

⊥ \_\_\_\_\_

= \_\_\_\_\_ =

\_\_\_\_\_

⊥ \_\_\_\_\_

\_\_\_\_\_

\_\_\_\_\_

\_\_\_\_\_

\_\_\_\_\_

\_\_\_\_\_

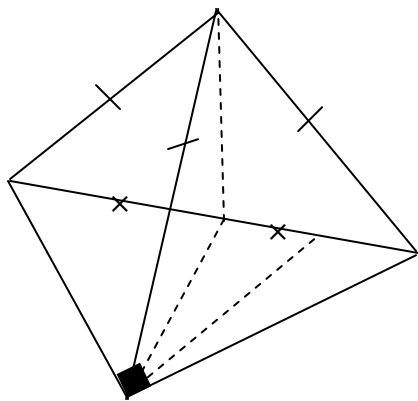

:( ) \_\_\_\_\_

Δ

= =

= = =

\_\_\_\_\_

\_\_\_\_\_

\_\_\_\_\_

⊃

\_\_\_\_\_

⊥ \_\_\_\_\_

\_\_\_\_\_

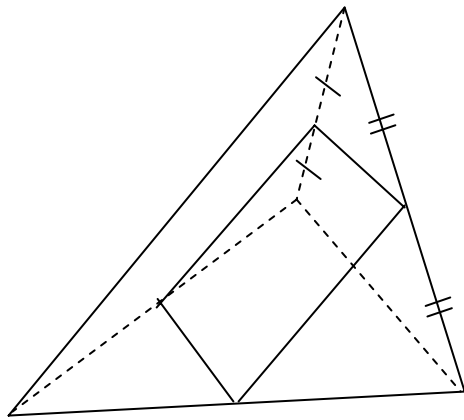

:( )

—  
—  
— = —  
— —  
⊥  
— —  
⊥  
:

⊥

:( )

= — = Δ ⊥ —  
: = = —  
⊥ —

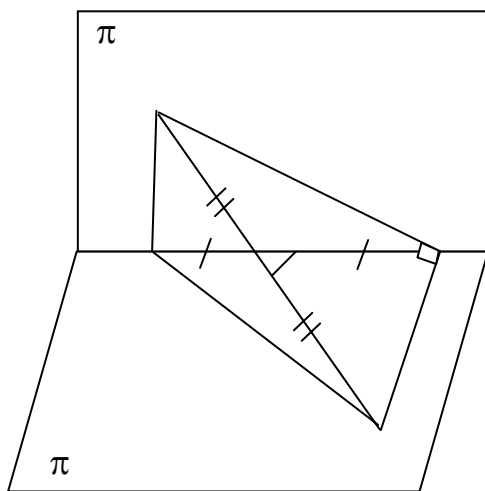

⇔  
= π W π π ⊥ π  
π ⊇ Δ  
° = ( ^ )  
π ⊇ Δ  
° = ( ^ )  
—  
— ⊥ — :

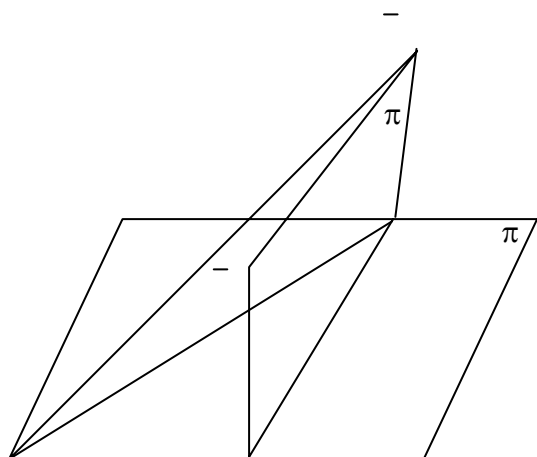

:( ) \_\_\_\_\_

- -

$\pi \perp \pi$

= - = = - = =

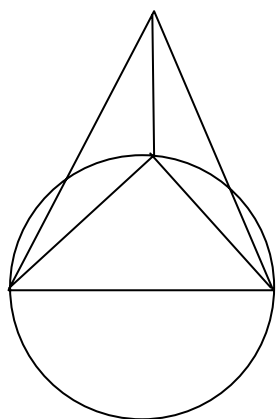

:( ) \_\_\_\_\_

\_\_\_\_\_

$\perp$  \_\_\_\_\_

:

\_\_\_\_\_  $\perp$  \_\_\_\_\_

-

-

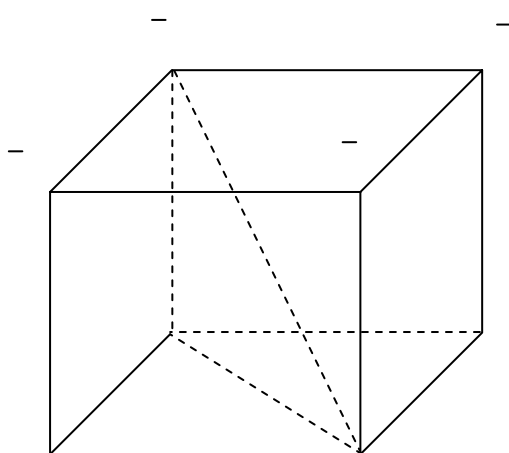

:( ) \_\_\_\_\_

- -

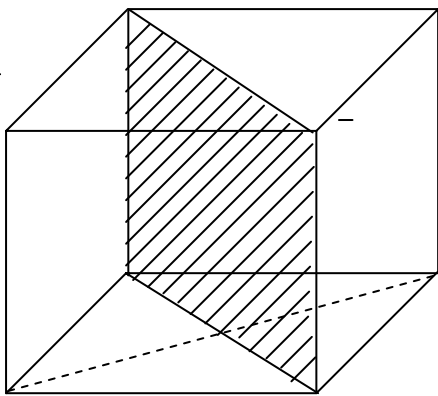

.....

:( ) \_\_\_\_\_

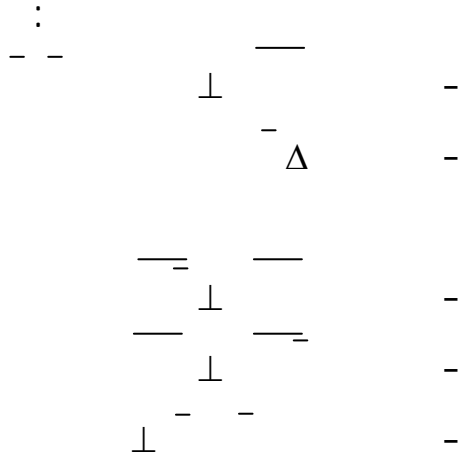

:( ) \_\_\_\_\_

⊥

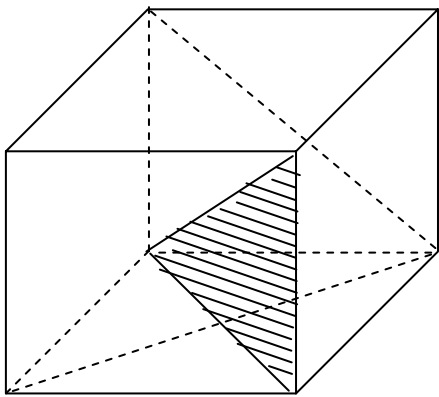

:( ) \_\_\_\_\_

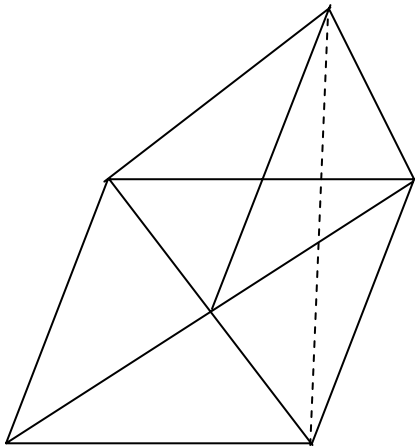

⊥ =

:

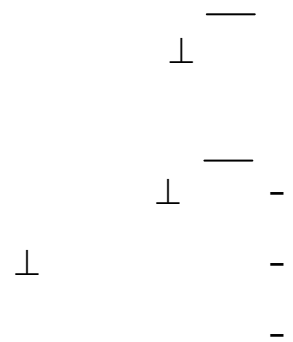

- -

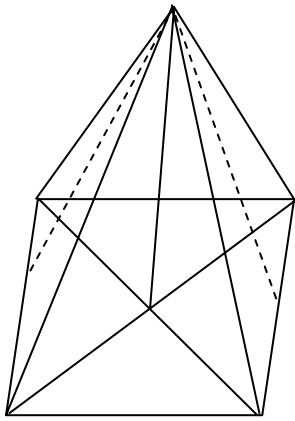

$$= \frac{\dots}{\dots} \quad \frac{\dots}{\dots} \quad \frac{\dots}{\dots}$$

$$\perp \quad \circ \quad \perp \quad \perp$$

$$= ( \quad \wedge \quad )$$

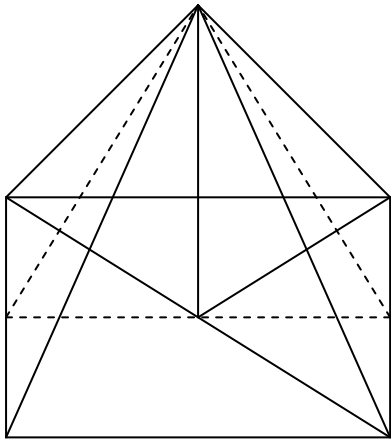

$$= \frac{\dots}{\dots} \quad \frac{\dots}{\dots} \quad \frac{\dots}{\dots}$$

$$\perp \quad \perp \quad \perp \quad \perp$$

$$= ( \quad \wedge \quad )$$